

865

+8.55

①

+6.10

+4.35

velux 78x98

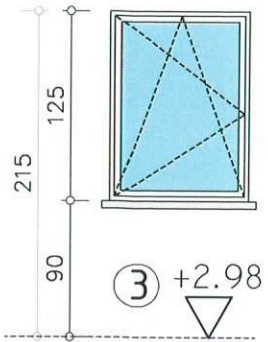

450

②

④

212,5

④

212,5

212,5

-0.15

0.00

⑤

⑤

⑤

Voorgevel
Lede, Houtzagerijstraat L4



referentiepeil 0.00

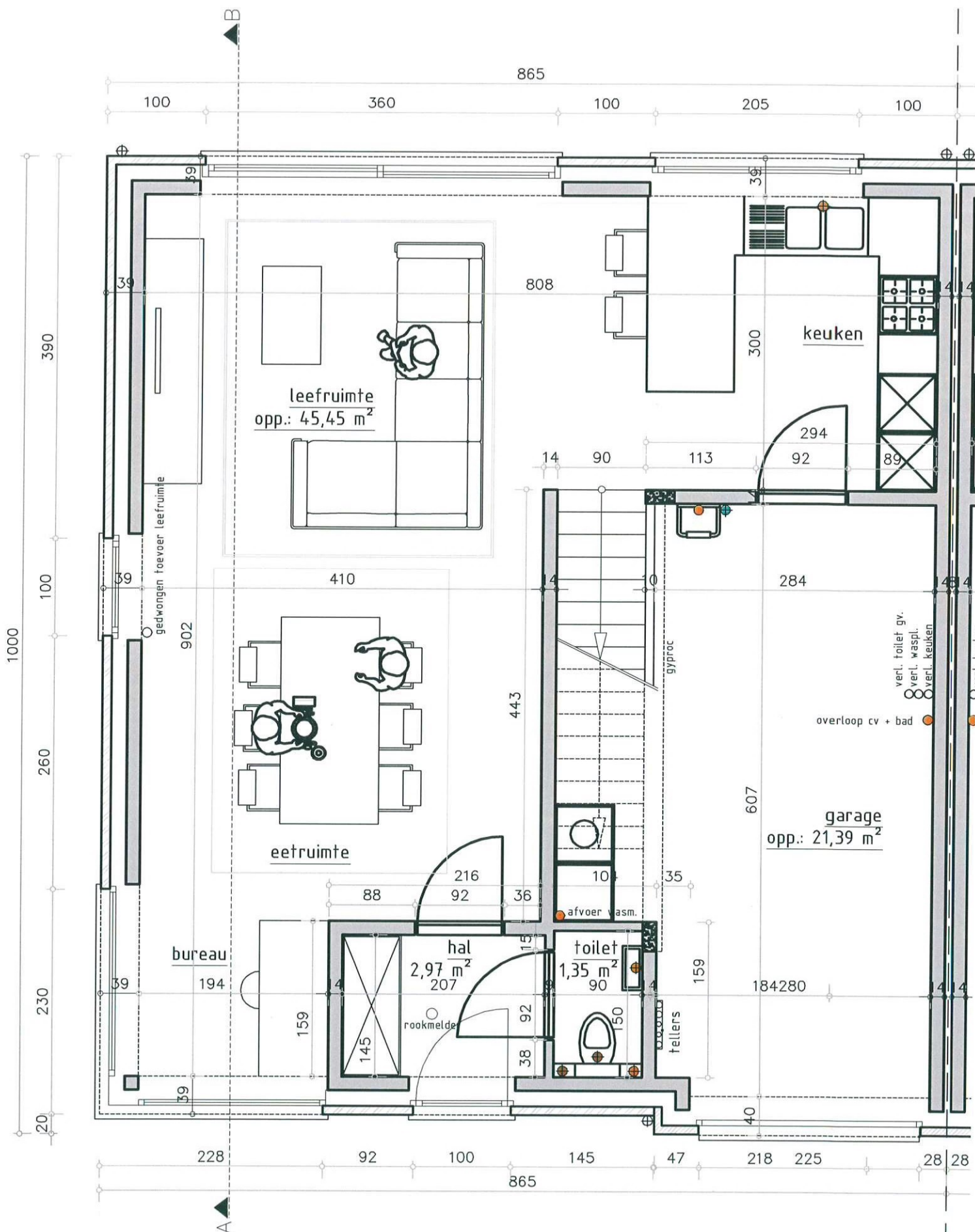

**Lede,
 Houtzagerijstraat L4**



refe

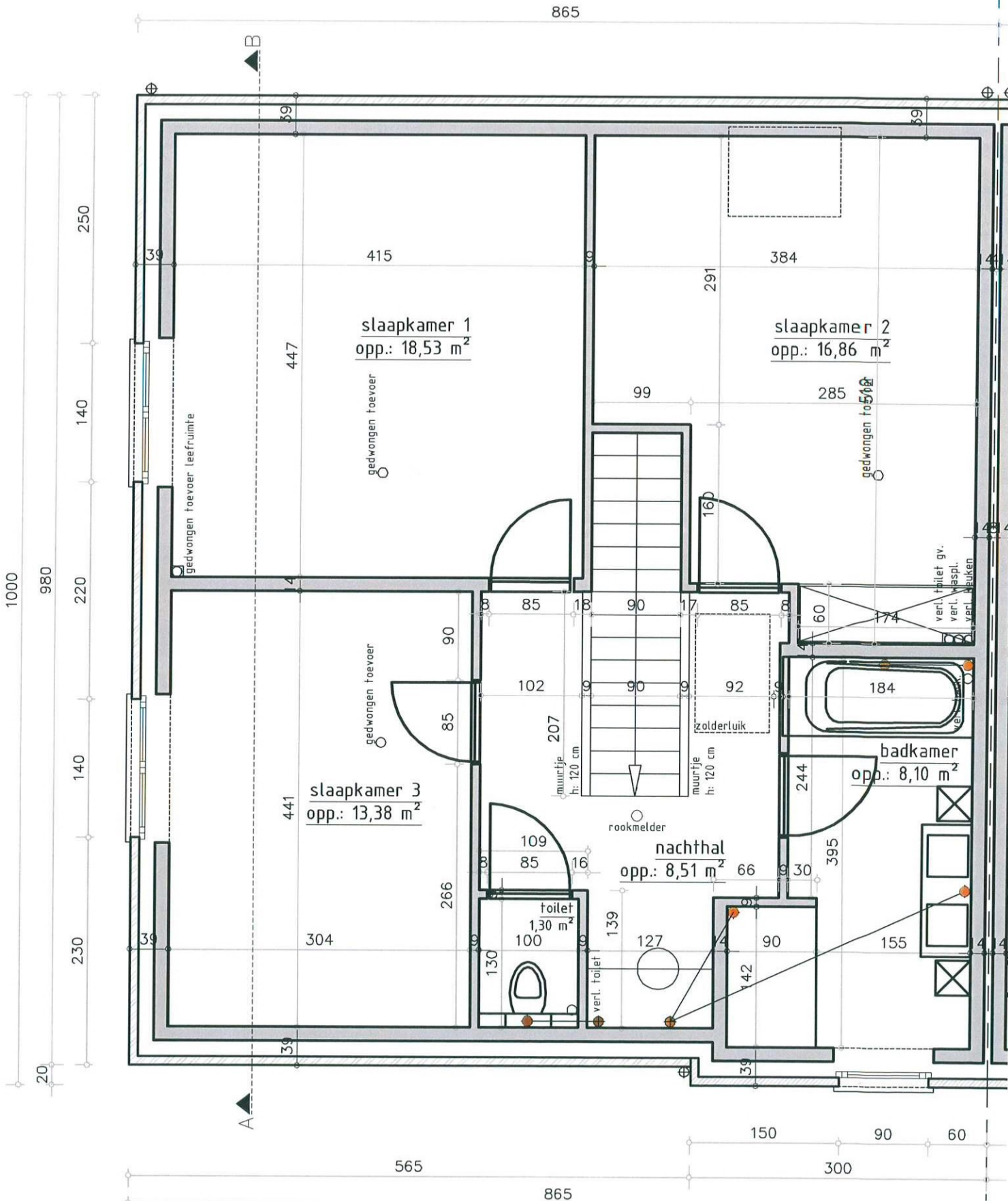

Lede,
Houtzagerijstraat L4



refe

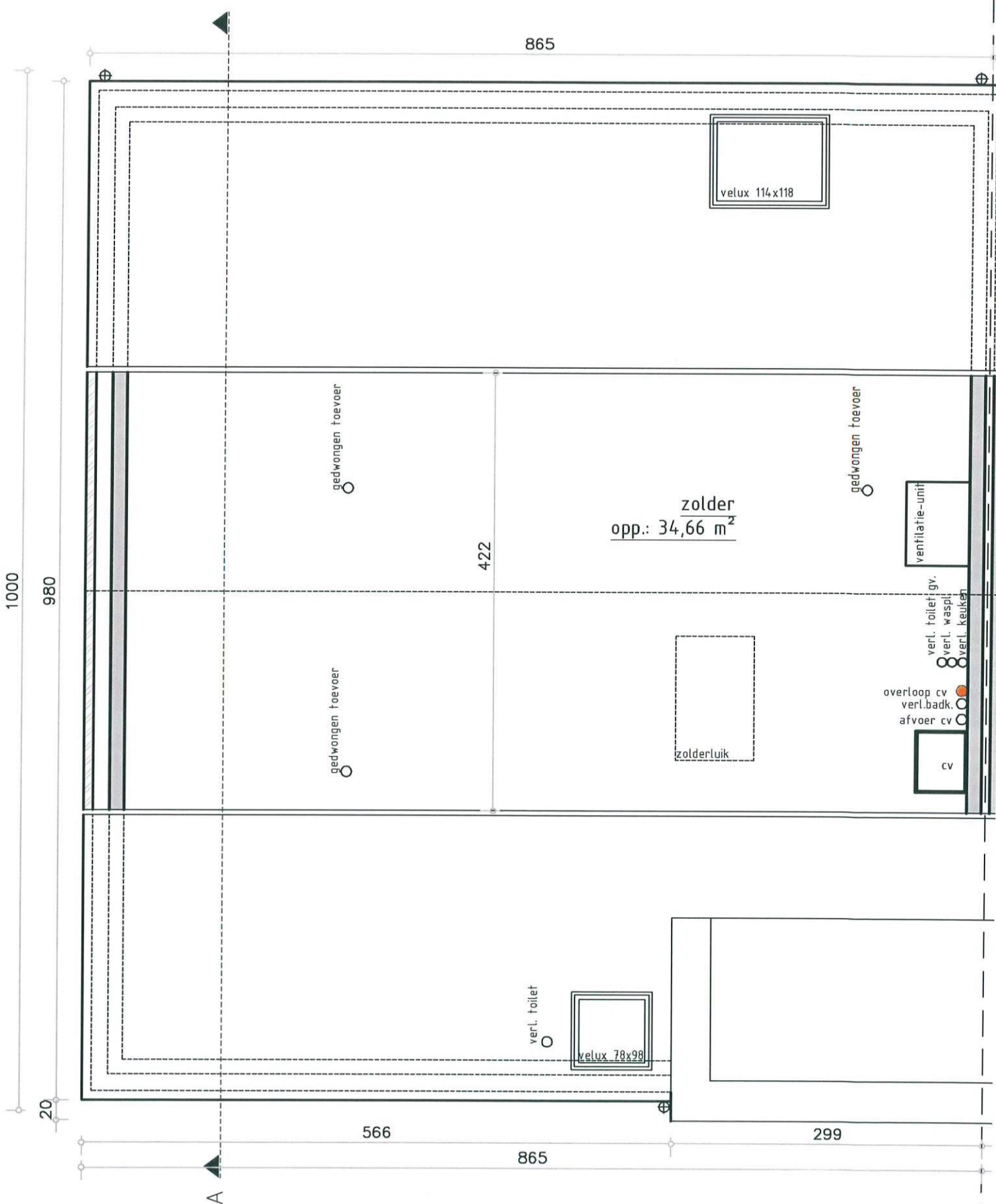

Lede, Houtzagerijstraat
L4



ref

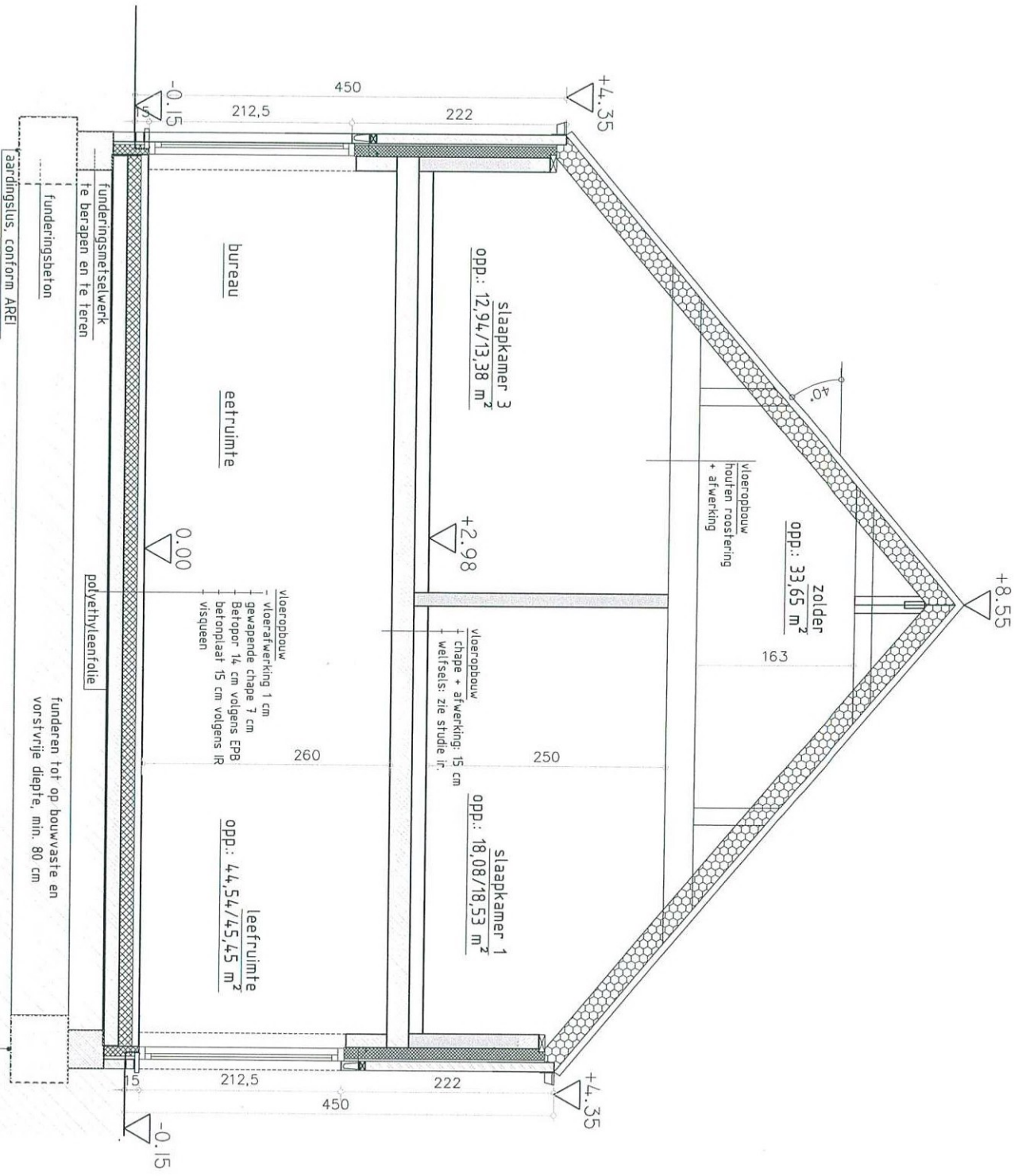

Lede,
Houtzagerijstraat L4



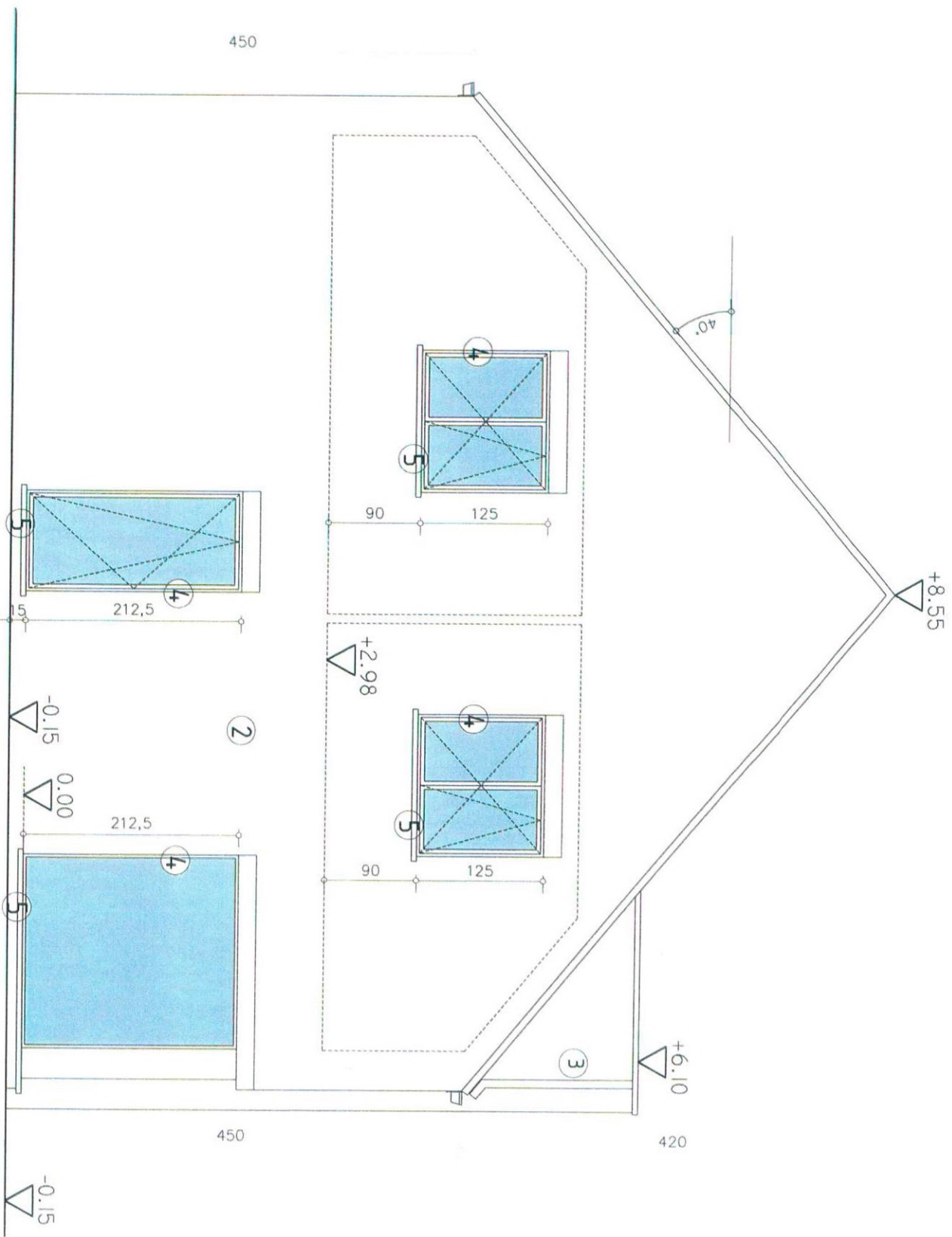

Zijgevel links L4
 Lede, Houtzagerstraat



865

+8.55

1

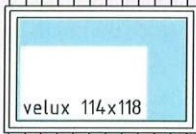

+4.35

2

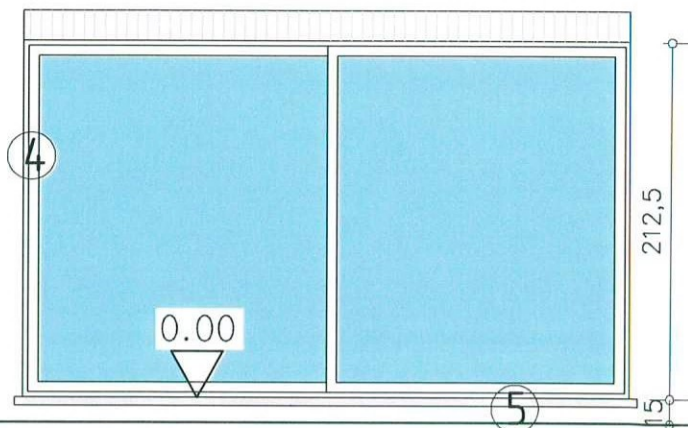
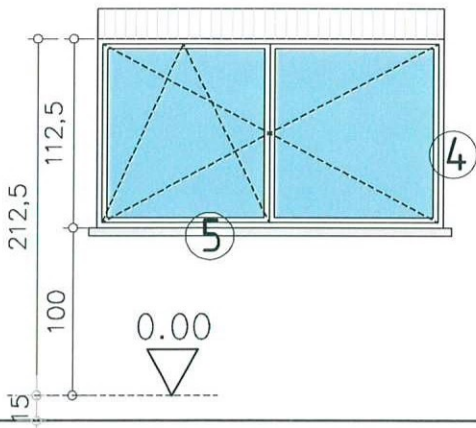

-0.15

Lede,
Houtzagerijstraat L4

